

prodotti **polverosi**  
 powdery products | productos en polvo

ITALPACK, grazie all'estrema flessibilità delle proprie linee di confezionamento, è in grado di gestire molteplici prodotti. L'efficienza dei sistemi di dosatura volumetrico a coclea permettono di confezionare prodotti polverosi di natura alimentare quali farina di grano, farina di mais, semola, nonché prodotti di natura diversa quali stucchi per l'edilizia, premiscelati e cementi.

Thanks to the extreme flexibility of ITALPACK's packing equipment most kinds of product can be packed. The efficient volumetric auger dosing systems allow to handle food products such as wheat flour, maize flour, semolina as well as non-food products like plaster, premix products and cements.

Gracias a la extrema flexibilidad de su propias líneas de embalaje, es capaz de gestionar diferentes productos. La eficiencia de los sistemas de dosificación volumétrico de coclea permiten confeccionar productos pulverulentos alimentares como harina de trigo, harina de maíz, sémola, así como productos diferentes como estucos por la construcción, pre-mezclados y cementos.



prodotti **polverosi**

powdery products | productos en polvo

A = 70÷140 mm  
B = 40÷90 mm  
H = 180÷360 mm

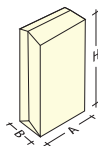

Produzione per **formati da 500g (25 cpm) a 2500g (18 cpm)**

Production for sizes from 500 g (25 cpm) to 2500 g (18 cpm)

Producción para formatos de 500 g (25 cpm) a 2500 g (18 cpm)





## Pack 25

*Confezionatrice automatica per sacchetti preformati di carta a fondo quadro*

*Automatic packing machine for ready-made, block-bottom bags*

*Empaquetadoras para bolsos preformados*

 **PACK 25** è il modello d'ingresso nel mondo ITALPACK. Semplice, robusta, efficace. È la confezionatrice ideale per produzioni fino a 25 CPM senza rinunciare alla consueta affidabilità e contenuti tecnologici che contraddistinguono tutti i prodotti ITALPACK.

 **PACK 25** is ITALPACK's entry level packing machine. Simple, strong, efficient. It's the ideal packing machine up to 25 bags per minute and presents all of ITALPACK's pro features of reliability and technological know-how.

 **PACK 25** es el modelo de acceso en el mundo ITALPACK. Simple, robusta, eficaz. Es la confeccionadora ideal para producciones hasta 25 confecciones/minuto sin renunciar a la usual fiabilidad y contenidos tecnológicos que caracterizan todos los productos ITALPACK.

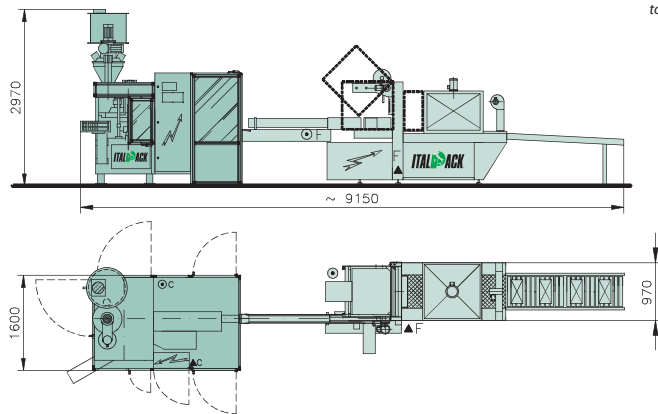

● **Magazzino d'introduzione sacchetti vuoti e stazione di riempimento**  
Empty bag loading magazine and bag filling station  
Depósito de introducción de los paquetes vacíos y banco de relleno

● **Datario inkjet**  
Inkjet date printer  
Fechaor inkjet



prodotti **polverosi**

powdery products | productos en polvo

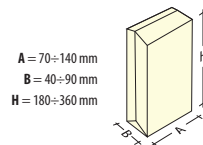

Produzione per formati da 500 g (42 cpm) a 2500 g (20 cpm)  
Production for sizes from 500 g (42 cpm) to 2500 g (20 cpm)  
Producción para formatos de 500 g (42 cpm) a 2500 g (20 cpm)





## Pack 50

*Confezionatrice automatica per sacchetti preformati di carta a fondo quadro*

*Automatic packing machine for ready-made, block-bottom bags*

*Empaquetadoras para bolsos preformados*

 PACK 50 è la scelta giusta per chi cerca una confezionatrice ITALPACK per medie produzioni. Semplice, robusta, efficace. È la confezionatrice ideale per produzioni fino a 42 CPM.

 PACK 50 is ITALPACK's medium capacity packing machine solution. Simple, strong, efficient. Capacity can reach up to 42 bags per minute.

 PACK 50 es la justa selección para quien está buscando una confeccionadora ITALPACK por medianas producciones. Simple, robusta, eficaz. Es la confeccionadora ideal para producciones hasta 42 confecciones/minuto.

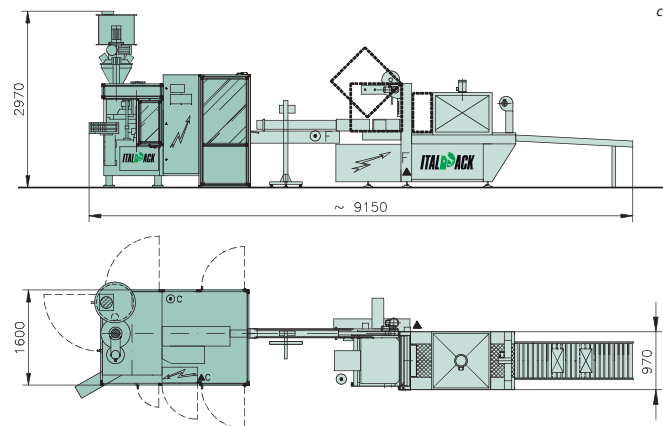

● Possibilità di installare di due dosatori volumetrici a coclea  
Optional installation of second volumetric doser  
Posibilidad de instalar dos dosificadores volumétricos



● Datario inkjet  
Inkjet date printer  
Fechador inkjet



prodotti **polverosi**

powdery products | productos en polvo

A = 80÷110 mm  
B = 50÷90 mm  
H = 220÷360 mm

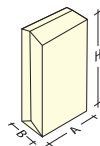



Alta produzione per **formati da 500 g (80 cpm) a 2000 g (45 cpm)**  
High-speed production for sizes from 500 g (80 cpm) to 2000 g (45 cpm)  
Alta producción para formatos de 500 g (80 cpm) a 2000 g (45 cpm)



## Pack 100

*Confezionatrice automatica per sacchetti preformati di carta a fondo quadro a doppia pista*  
Double-lane packers for ready-made, block-bottom bags  
Empaquetadoras con vía doble para bolsos preformados

 PACK 100 è progettata per offrire una produttività elevata gestendo due sacchetti contemporaneamente durante tutte le fasi del ciclo automatico. La capacità produttiva può arrivare fino a 80 CPM.

 PACK 100 is designed for high capacity requirements and can fill and close two bags at the same time. Production capacity can reach up to 80 bags per minute.

 La PACK 100 es planeada para ofrecer una elevada productividad gestionando simultáneamente dos paquetes durante todas las fases del ciclo automático. La capacidad productiva puede llegar hasta 80 confecciones/minutos.



Riempimento ed assestamento prodotto ●  
Product filling and assesment  
Relleno y asentamiento del producto

Doppio magazzino per sacchetti vuoti ●  
Twin empty bag magazine  
Doble depósito por paquetes vacíos

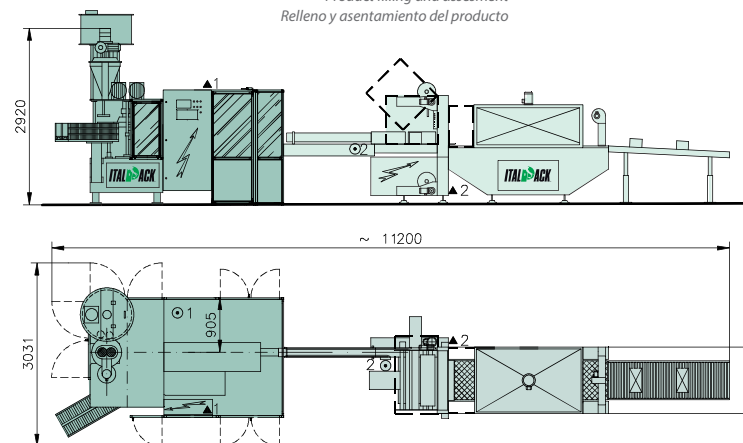

prodotti **polverosi**

powdery products | productos en polvo

A = 80÷105 mm  
B = 50÷90 mm  
H = 220÷320 mm

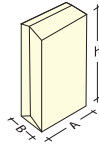

Alta produzione per **formati da 500 a 1000 g** con velocità fino a **100 CPM**  
High-speed production for sizes from 500 to 1000 g with speeds up to 100 bags per minute  
Alta producción para formatos de 500 a 1000 g con velocidad hasta 100 CPM





## Pack 100/3

**Confezionatrice automatica per sacchetti preformati di carta a fondo quadro a tripla pista**

*Triple-lane packers for ready-made, block-bottom bags*

*Empaquetadoras con vía doble para bolsos preformados en carta a fondo cuadro a triple pista*

 PACK 100/3 è l'evoluzione del concetto introdotto con la confezionatrice PACK 100 nel proporre una soluzione "multi-pista". In questo caso tre sacchetti vengono riempiti e chiusi contemporaneamente riuscendo così ad ottenere una capacità produttiva di 100 CPM.

 PACK 100/3 is the evolution of the "multi-lane" new concept introduced with PACK 100. In this case three bags are filled and closed as the same time allowing to reach a production capacity of 100 bags per minute.

 La PACK 100/3 es la evolución del concepto introducido con la confeccionadora PACK 100, es decir, proponer una solución "multipista". En este caso tres paquetes son llenados y cerrados al mismo tiempo consiguiendo así una capacidad productiva de 100 confecciones/minuto.

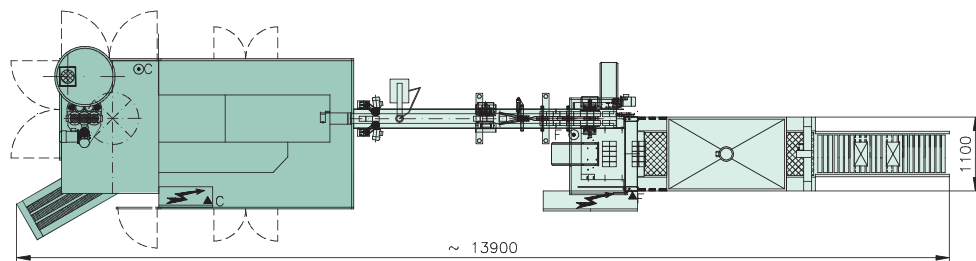
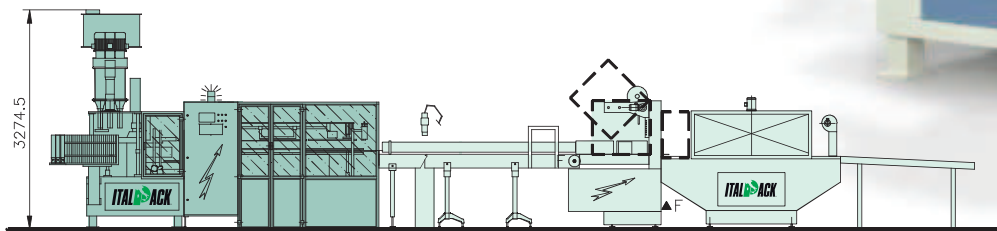

Incollatore hot melt a spruzzo ●  
Hot melt glue unit with spray system  
Encolador hot melt con pistola

● Sistema di alimentazione e dosatura del prodotto  
Product feeding and dosing system  
Sistema de alimentación y dosificación del producto



prodotti **polverosi**

powdery products | productos en polvo

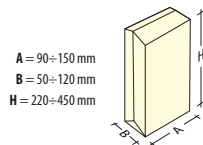



Alta produzione per **formati da 1000 g (65 cpm) a 2500 g (45 cpm)**  
High-speed production for sizes from 1000 g (65 cpm) to 2500 g (45 cpm)  
Alta producción para formatos de 1000 g (65 cpm) a 2500 g (45 cpm)



# Pack 100/M

*Confezionatrice automatica per sacchetti preformati di carta a fondo quadro a doppia pista*  
Double-lane packers for ready-made, block-bottom bags  
Empaquetadoras con vía doble para bolsos preformados

 **PACK 100/M** mantiene una certa flessibilità potendo gestire formati che variano da 1000 a 2500 g aumentando la produttività implementando anche la gestione contemporanea di due sacchetti. La capacità produttiva può arrivare fino a 65 CPM.

 **PACK 100/M** remains a very flexible packing machine as it can handle bags that vary from 1000 to 2500 g but with more production capacity by filling and closing two bags at the same time. Production capacity can reach up to 65 bags per minute.

 **La PACK 100/M** tiene mucha flexibilidad pudiendo gestionar formatos que varían de 1000 a 2500g aumentando la productividad implementando también la gestión contemporánea de dos paquetes. La capacidad productiva puede llegar hasta 65 confecciones/minuto.

● **Aspirazione polveri**  
Dust aspiration  
Aspiración de polvos

● **Rifilo e chiusura dei sacchetti**  
Trimming and bag closing  
Corte y cierre de los paquetes

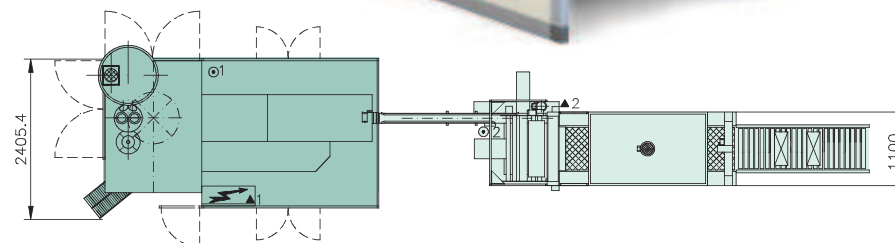
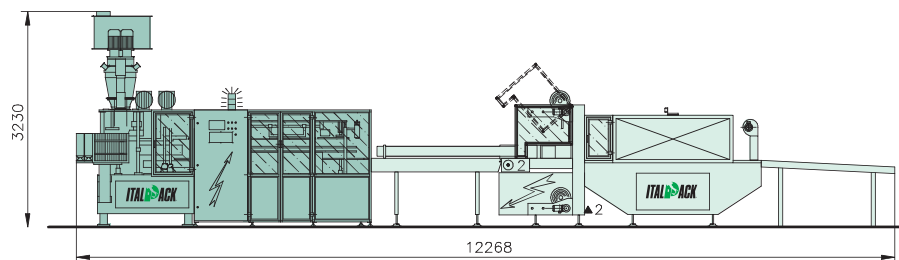
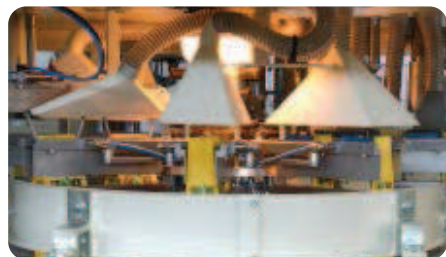

prodotti **polverosi**

powdery products | productos en polvo

A = 90÷240 mm  
B = 50÷130 mm  
H = 220÷520 mm

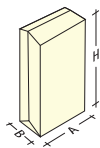

Alta produzione per **formati da 1000 g (38 cpm) a 5000 g (22 cpm)**

Production for sizes from 1000 g (38 cpm) to 5000 g (22 cpm)

Producción para formatos de 1000 g (38 cpm) a 5000 g (22 cpm)





## Pack 50/5

*Confezionatrice automatica per sacchetti preformati di carta a fondo quadro di medie e grandi formati*

*Automatic packing machine for medium and large sized ready-made, block-bottom bags*  
*Empaquetadoras para bolsos preformados en carta a fondo cuadro de formatos medios y grandes*

 **PACK 50/5** nasce per poter offrire la massima flessibilità e produttività potendo gestire sacchetti aventi formati che variando da 500 a 5000 g. Grazie alla possibilità opzionale di poter installare un secondo dosatore, la produttività con il formato da 5000 g può arrivare fino a 22 CPM.

 **PACK 50/5** offers flexibility together with production capacity being able to handle bags varying from 500 to 5000 g. Thanks to the possibility to install a second optional doser, this packing machine can reach up to 22 bags per minute with 5000 g bags.

 **La PACK 50/5** nace para poder ofrecer la máxima flexibilidad y productividad pudiendo gestionar paquetes que tienen formatos que varían de 500 a 5000 g. Gracias a la posibilidad opcional de poder instalar un segundo dosificador, la productividad con el formato de 5000 g puede llegar hasta 22 confecciones/minuto.



● Possibilità di installazione di due dosatori volumetrici a coclea  
Optional installation of second volumetric doser  
Posibilidad de instalar dos dosificadores volumétricos

● Rifilo e chiusura dei sacchetti  
Trimming and bag closing  
Corte y cierre de los paquetes

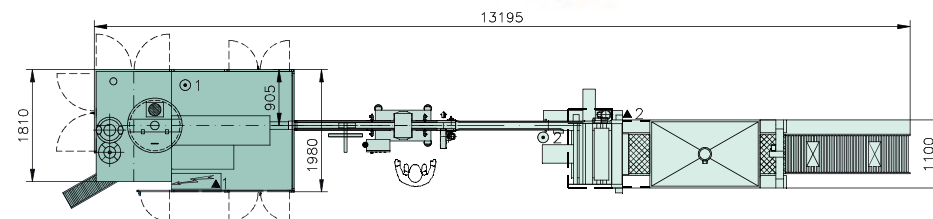
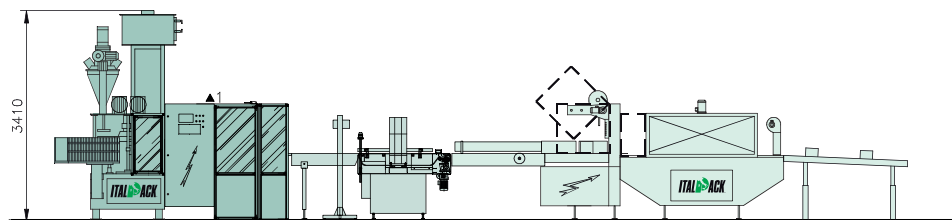

prodotti **polverosi**

powdery products | productos en polvo

A = 90÷180 mm  
B = 50÷130 mm  
H = 220÷460 mm

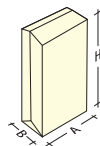

Produzione per **formati da 1000 g (65 cpm) a 5000 g (40 cpm)**

Production for sizes 1000 g (65 cpm) to 5000 g (40 cpm)

Producción para formatos de 1000 gr (65 cpm) a 5000 gr (40 cpm)





## Pack 100/S

*Confezionatrice automatica ad alta produzione per sacchetti preformati di carta a fondo quadro di medie formati*

*High capacity automatic packing machine for medium sized ready-made, block-bottom bags*

*Empaquetadoras alta producción para bolsos preformados en carta a fondo cuadro de formatos medios*

 PACK 100/S è stata progettata specificamente per ottenere la massima produzione con formati medi, es. 5000 g, e pertanto utilizza un sistema di doppio dosatore a due coclee unito al contemporaneo riempimento e la chiusura di due sacchetti. La capacità produttiva raggiungibile è di 40 CMP.

 PACK 100/S combines both the use of two twin auger dosers together with filling and closing two bags at a time to obtain maximum capacity for medium size bags: i.e. 5000 g. Production capacity reaches 40 bags per minute.

 La PACK 100/S es proyectada específicamente para obtener la máxima producción con formatos medios, ej. 5000 g y por eso utiliza un sistema a doble dosificador a dos cocleas unido al contemporáneo relleno y al cierre de dos paquetes. La capacidad productiva puede llegar hasta 40 confecciones/minuto.

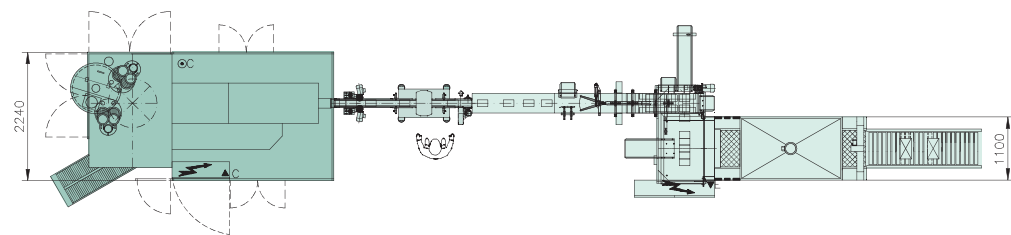
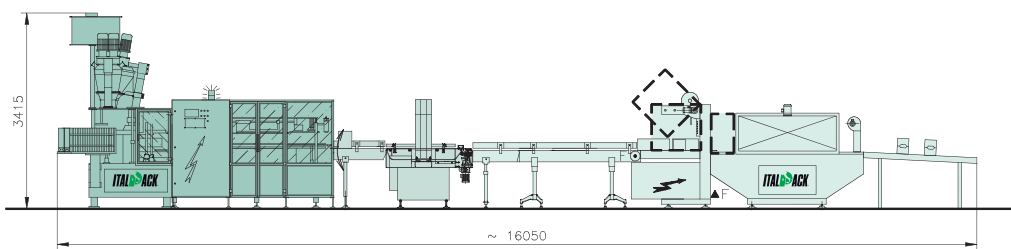

Doppio magazzino per sacchetti vuoti ●  
Twin empty bag magazine  
Doble depósito por paquetes vacíos

● Rifornimento ed assetamento prodotto  
Product filling and assesment  
Relleno y asentamiento del producto





prodotti **polverosi**

powdery products | productos en polvo

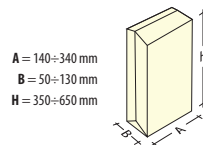

Produzione per **formati da 2500 g a 12500 g** con velocità fino a **20 CPM**  
High-speed production for sizes 2500 to 12500 g with speeds up to 20 bags per minute  
Alta producción para formatos de 2500 to 12500 g con velocidad hasta 20 CPM





## Pack 50/10

*Confezionatrice automatica per sacchetti preformati di carta a fondo quadro di grandi formati*

*Automatic packing machine for large sized ready-made, block-bottom bags*

*Empaquetadoras para bolsos preformados a fondo cuadro con formatos grandes*

 PACK 50/10 è studiata per offrire capacità medie ed alte, in base alla configurazione scelta, per sacchetti di grandi dimensioni variando da 2500 a 12500 g.

 PACK 50/10 is designed to handle medium and large size bags ranging from 2500 to 12500 g and capacity varies based on the chosen configuration.

 La PACK 50/10 es estudiada para ofrecer capacidades medias y altas sobre la base de la configuración seleccionada, por paquetes de grandes dimensiones variando de 2300 a 12500 g.



● Sistema di dosatura del prodotto  
Product dosing system  
Sistema de dosificación del producto



● Aspirazione polveri  
Dust aspiration  
Aspiración de polvos

